

LET
LIGHT
ALULED
LIVE

SCANGIFT®

WWW.SCANGIFT.COM

ALULED™ bar collection

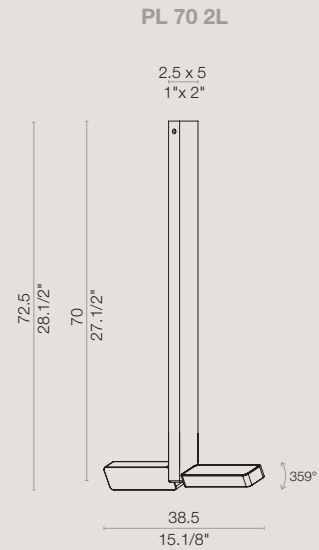
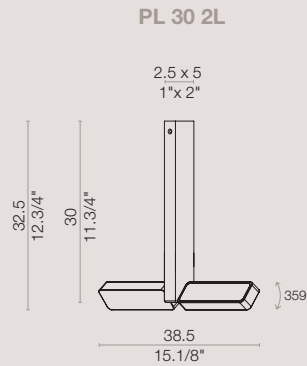
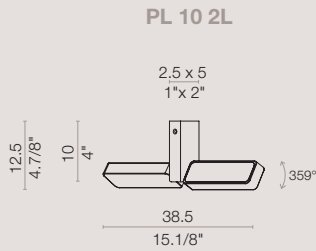
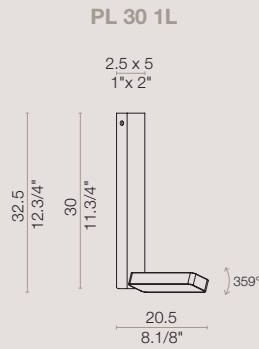
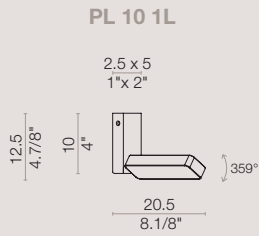
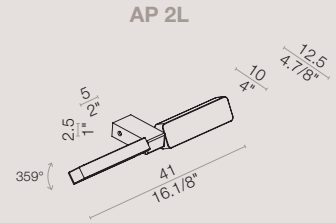
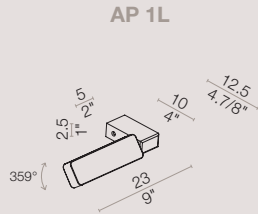
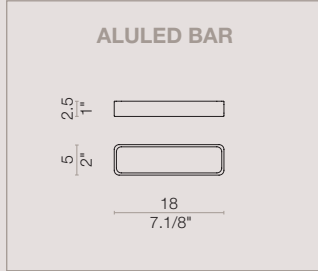

PROJECT:

TYPE:

MODEL # FINISH/COLOUR WATTAGE LIGHT SOURCE VOLTAGE



[En] → Lighting fixture in carved solid aluminium, powder-coated available in 4 colors and concrete finish. White PMMA diffuser. LED 220-240V. 359° adjustable version as wall/ceiling lamp. Frame in powder-coated aluminium, available in 4 colors. Chromed metal joint.

[It] → Corpo illuminante in alluminio ricavato dal pieno verniciato a polveri nei 4 colori disponibili e finitura cemento. Diffusore in PMMA bianco. Sorgente LED 220-240V. Versione orientabile 359° parete e plafoniera. Montatura in alluminio verniciato a polveri nei 4 colori disponibili. Snodo metallo cromato.

material

aluminium
alluminio

light source

LED 220-240V

120V for
NORTH AMERICA

Dimmer not included
Dimmer non incluso

photometric test BAR

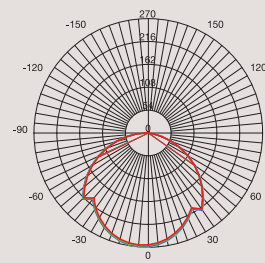

AVERAGE BEAM ANGLE(50%):119,2 DEG

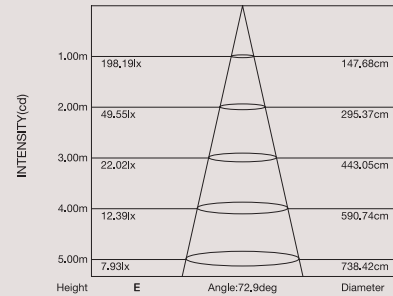

equipment

AP 1L / PL 10 - 30 - 70 1L
13.5W LED 3000°K lm1450

AP 2L / PL 10 - 30 - 70 2L
27W LED 3000°K lm2900

Available 4000°K /
Disponibile 4000°K

symbols



colors



white / bianco
RAL 9010

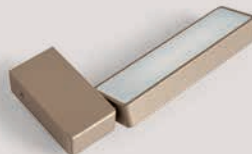

dove / tortora
RAL 1019

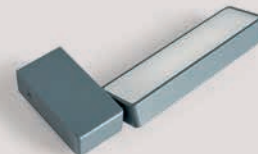

grey / grigio
RAL 7031

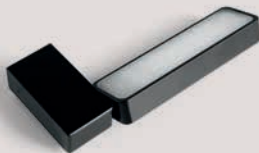

black / nero
RAL 9005



concrete / cemento

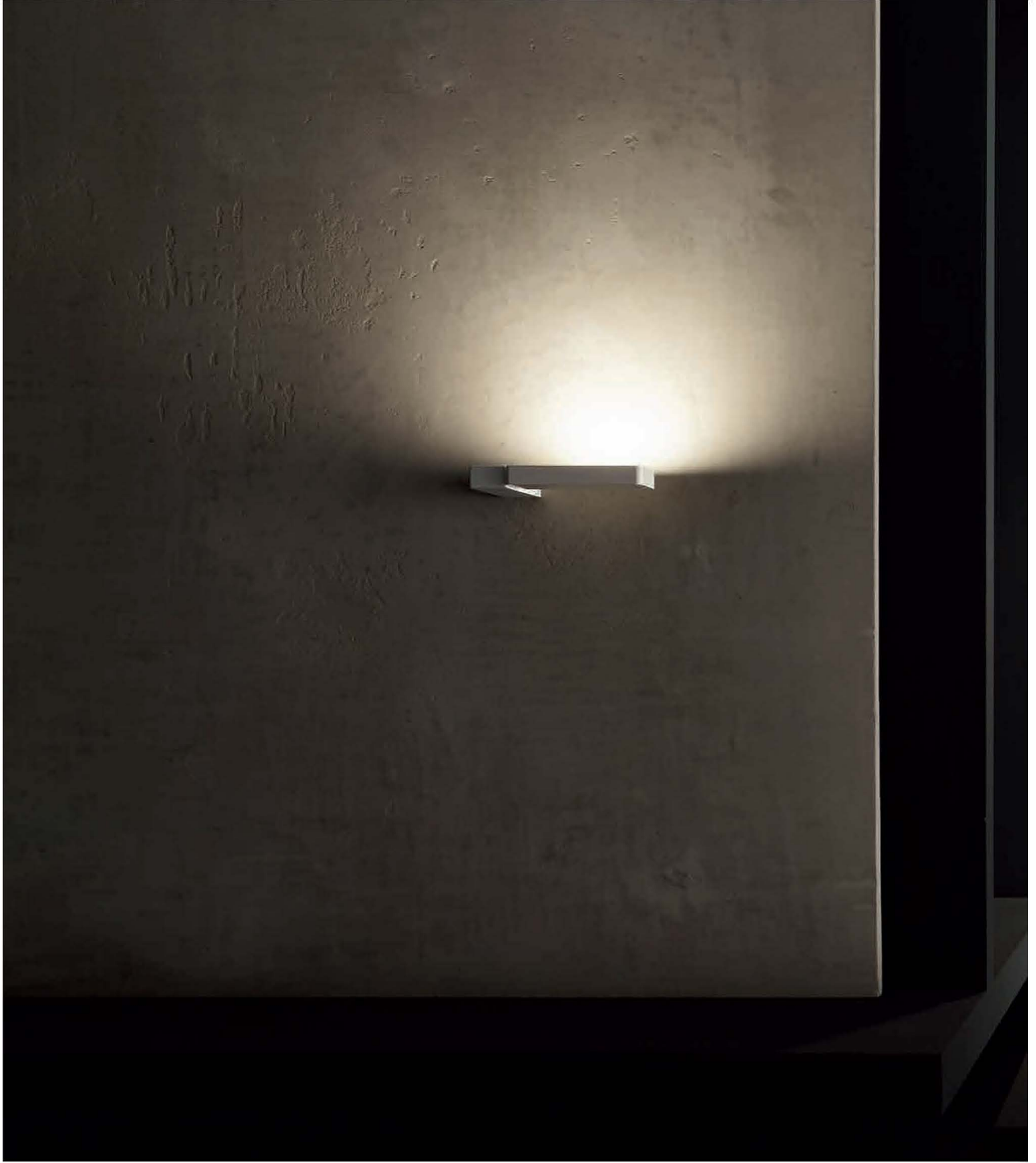





ALULED™
→ **bar**

[En] → Among the various available finishes, the concrete effect version is enhanced by a consistent texture, which contrasts with the minimalist design of the fixtures. This feature is emphasized in the version with junction, because by rotating its structure it is possible to touch and feel the roughness of concrete.

[It] → Tra le varie finiture disponibili, la versione effetto cemento è arricchita da una texture materica che contrasta con il design minimale della lampada. Questa caratteristica viene sottolineata nella versione snodabile in cui è possibile toccare e sentire la rugosità del cemento nel momento in cui il corpo illuminante viene ruotato.



ALULED bar

AP 1L
wall lamp

dimensions
W 23 x DPT 12.5 cm

colors
white 9010

[En] → The junction version of ALULED BAR has a 359 degrees rotation, directing the light at wish.

[It] → La versione snodabile di ALULED BAR permette la rotazione di 359 gradi del corpo illuminante, direzionando in questo modo la luce.



[En] → Both the junction and lighting element of ALULED BAR can be fitted in different ways: structure and single lighting fixture, or structure and double lighting fixture. It is possible to change the finishes of these parts, obtaining in this way several combinations.

[It] → Snodo ed elemento luminoso di ALULED BAR possono essere composti in diversi modi: montatura e corpo illuminante singolo oppure montatura e corpo illuminante doppio. Inoltre è possibile variare le finiture di queste parti ottenendo molteplici combinazioni.